

INSTRUCTIONS FOR USE

and fitting



EN

B6350.0
CB6350.0
BP6350.0



Küppersbusch

Please read the users instructions carefully before installation of the appliance and before starting to use it.
Please, store these instructions carefully.

Service and Customer Service

Phone: +49 -209401-631

Email: kundendienst@kueppersbusch.de

Küppersbusch
FÜR KÜCHEN MIT STIL

BP6350.0

Technical Drawing

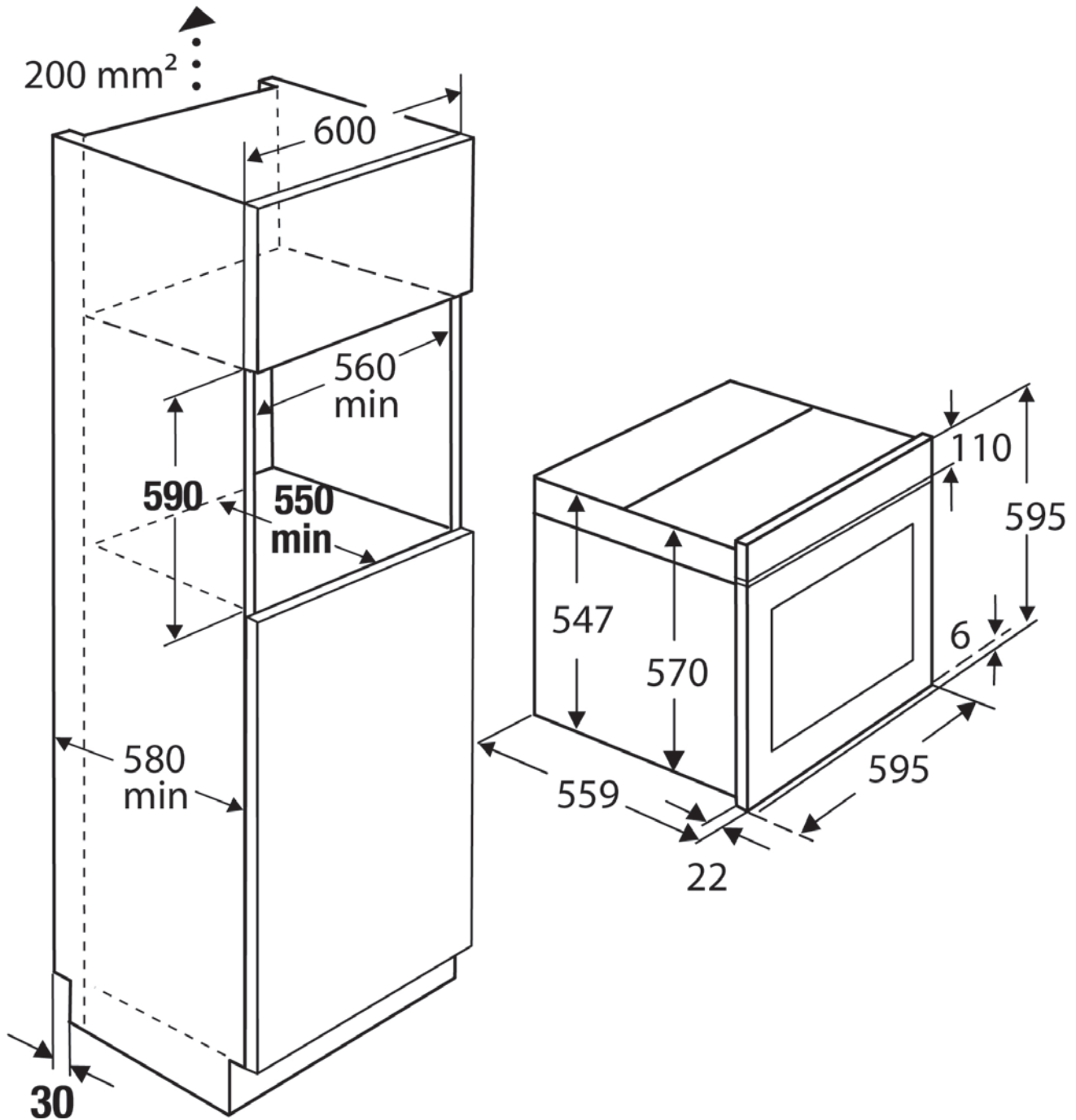

Contents

Copyright	4	7. Overview of your oven	28
Amendments	4	7.1. Control panel - sensor keys and displays.....	29
Completeness	4	8. Basic settings.....	30
Software	4	8.1. Setting the clock	30
Availability of the instructions.....	4	9. Roasting and baking charts	31
1. Explanation for symbols and indications	6	9.1. Guidelines for roasting.....	34
2. Safety Instructions and Warnings	8	9.2. Guidelines for grilling	36
2.1. For connection and operation.....	8	9.3. Recommended food probe temperatures.....	37
2.2. Switching On and Operating.....	8	9.4. Low-temperature cooking guidelines.....	39
2.3. Oven.....	9	10. Oven functions.....	41
2.4. For persons	10	10.1. Cooking functions.....	41
2.5. Before using the first time.....	10	10.2. Special functions	42
2.6. Environmental Protection	11	11. Operating the oven	44
2.7. Energy information	11	11.1. Switching on the oven.....	44
2.8. Intended purpose.....	11	11.2. Switching the oven off.....	44
3. Cleaning and care	13	11.3. Selecting one cooking function.....	44
3.1. For all surfaces.....	13	11.4. Changing a setting during the cooking process....	45
3.2. Cleaning the oven door	16	11.5. Automatic programme.....	45
3.3. Pyrolytic self-cleaning of the oven	17	11.6. Time settings.....	49
4. Before using the first time	17	11.7. Memory function	54
4.1. Important instructions	18	11.8. Rapid heating	55
5. Accessories.....	19	11.9. Childproof lock.....	55
5.1. Glide-out shelves with folding clip	19	11.10. Setting the demo mode.....	56
5.2. Glide-out shelves with direct clip	20	11.11. Factory settings.....	56
5.3. Cleaning the oven accessories.....	21	12. Special settings and additional settings and functions specific to models	57
6. Maintenance work.....	21	12.1. Pyrolytic function	57
6.1. Replacing the oven lamp	21	13. What to do if	58
6.2. Removing the oven door	22		
6.3. Dismantling/assembling the interior glass of the door	25		
6.4. Dismantling/assembling the shelf runners.....	26		
6.5. Dismantling the rear wall	27		

Küppersbusch Customer Service Germany

Küppersbusch Hausgeräte GmbH
Küppersbuschstraße 16
45883 Gelsenkirchen

Phone: +49-209401-631

Fax: (02 09) 401-714 / -715

Internet: www.kueppersbusch.de

We are available as follows:

Monday to Thursday from 8.30 a.m. – 6 p.m.

Friday from 8.30 a.m. – 5 p.m.

Please inform us by fax or internet of your requirements outside of these official hours at www.kueppersbusch.de.

Austria:

Teka Austria GmbH
Eitnergasse 13
1230 Vienna

Phone: +43 1 8 66 80-15

Fax: +43 1 8 66 80-50

Internet: www.kueppersbusch.at

We are available as follows:

Monday to Thursday from 8.00 a.m. to 5.00 p.m.

Please inform us by fax or internet of your requirements outside of these official hours at www.kueppersbusch.at

1. Please note:
We require the following details for your request for customer service so that our customer service technicians can be well-prepared for carrying out any repairs and have the required spare parts available:
2. Your exact address
3. Your telephone number and, if available, your fax number
4. When can customer service call?
5. An exact appliance designation: Model number and production number (F-No.) (refer to the nameplate and/or the receipt)
6. The date of purchase or delivery
7. An exact description of the problem or what kind of service you require. Please have your receipt available. This will help us to avoid wasting time as well as cutting down on expenses and we will be able to work more efficiently for you.

Copyright

This documentation is protected by copyright. Any rights duly derived, in particular those concerning its translation or reproduction, the extraction of images, radio broadcasts, photomechanical or similar reproduction and its storage in data processing systems, shall be reserved even in the event of being only partially used.

KÜPPERSBUSCH makes no representations or warranties with respect to the contents of these operating instructions and explicitly declines to assume responsibility for any implicit claims for defects.

KÜPPERSBUSCH furthermore reserves the right to update this publication and make amendments without entering into a commitment to inform each person of these amendments.

Amendments

Texts, images and data comply with the technical standard of the oven at the time of these operating instructions going to press. We reserve the right to make amendments in line with its further development.

Completeness

This document has altogether 60 pages. Your document is complete if all the pages you have are numbered consecutively.

Software

Please note that these instructions apply for various series of equipment. Details that possibly do not apply for your appliance may be described.

Availability of the instructions

The operating instructions must be permanently at the disposal of the user in order to ensure reliable use. The instructions are to be stored in an easily accessible place at which they can be viewed at any time.

Dear new Küpperbusch appliance user...

Don't worry, it's not going to be that complicated. We have made every effort structure this information briefly and succinctly, clearly and explicitly, and above all, logically.

In addition to the instructions given by our Customer Service, these instructions aim at enabling you to be able to operate this appliance quickly.

The individual sections classify the instructions in individual topics to give you a better overview and faster access. Please read the information in these instructions carefully before you use your oven for the first time. You will find important guidelines about safety and information about the use, care and maintenance of your appliance to ensure that it provides you with many years of service.

The purpose of these operation instructions

When you use the appliance for the first time, the instructions will take you step-by-step through the individual functions, applications and operation stages.

The section on "**Safety Instructions and Warnings**" gives you important information on your safety and on the use, care and maintenance of your appliance and its attachments, and it informs you about potential danger.

The section on "**Operation Instructions**" introduces you to the appliance, tells you what it's for, what it can do and how it works, shows you how to set it up and shows you the menu guide.

The section on "**What to do if..?**" is for finding faults - just in case. You will find useful information on faults and errors.

Once you have had some time to become familiar with the appliance, you can look up specific sections or topics if you are in any doubt. Please keep this manual in a safe place. Hand these instructions for use over to any new owner for the purpose of their information and safety.





1. Explanation for symbols and indications

The appliance was produced according to state of the art technology. Machines nevertheless give rise to risks which cannot be constructively avoided.

In order to guarantee sufficient safety for the use, safety instructions are also given. These instructions are marked by way of the highlighted texts which follow.

Sufficient safety in operation will only be guaranteed when these instructions are observed. The designated text passages have different meanings:

The following danger symbols are used at some points:

	DANGER Note indicating an imminent threat which may result in death or very serious injury.
	CAUTION Note indicating an imminent threat which may result in death or very serious injury.
	DANGER Note indicating a dangerous situation which may result in minor injury or damage to the appliance.
	HINT Note to be observed in order to make handling the appliance easier.

The following danger symbols are used at some points:

	WARNING OF ELECTRICAL ENERGY RISK OF FATAL INJURY! Live components have been installed near this symbol. Covers bearing this sign may only be removed by a certified skilled electrician.
--	--



OBSERVE REGULATIONS FOR HANDLING ELECTROSTATICALLY SENSITIVE COMPONENTS AND MODULES (ESDS).

Electrostatically endangered components and modules are located behind covers bearing the adjacent symbol. Never touch plug connections, strip conductors or component pins. Only qualified staff members who are familiar with ESDs are authorised to carry out any technical intervention work.



HOT SURFACES!

This symbol has been applied to surfaces which get hot. There is a risk of serious burning or scalding. The surfaces may also be hot after the appliance has been switched off. This symbol warns of a risk of burning.

Check consignment

Transport the oven to a suitable place and remove it from its packaging there. The oven may only be assembled and installed by an electrician who complies with the respective specifications.

Check to ensure that the consignment is complete.

- Check the oven for any transport damage.
- Contact our Customer Service if the consignment is incomplete or if the oven shows any transport damage.



CAUTION!

Never put a damaged appliance into operation!

2. Safety Instructions and Warnings

2.1. For connection and operation

- Only KÜPPERSBUSCH ovens have been manufactured and tested for use under a KÜPPERSBUSCH hob. Do not use other hobs.
- Any handling or repair to the appliance, including replacement of the power cable, should be carried out by authorised Technical Service Personnel using original spare parts. Repairs or handling by others may damage the appliance or cause malfunctioning that could be hazardous to your safety.
- Statutory regulations and the connection specifications issued by the local power supply company must be strictly observed.
- The power supply to the appliance must be disconnected when the oven lamp is connected, repaired or replaced. Disconnect the fuse or pull out the power plug.
- Installation must guarantee full safety against any potential contact.
- Changing the installation location of a plug and replacing the mains cable may only be carried out by an electrician who complies with the respective specifications.
- It is essential for the connection data (frequency and voltage) of the oven to comply with that of the mains electricity supply in order for the oven not to be damaged. Compare this data when connecting the oven. If in any doubt, ask a qualified electrician.
- Multiple sockets and extension cables do not sufficiently guarantee safety (risk of fire). Do not use them to connect the oven to the mains electricity supply.
- Only use the oven when it has been installed in order to guarantee that it functions safely.
- Make sure that no electric cable from a free-standing or built-in appliance makes contact with the oven.

2.2. Switching On and Operating

- Do not allow children to come near the oven while in use as it can reach very high temperatures.
- Children should be supervised in order to ensure that they do not play with the appliance.

- This appliance is not for use by persons (including children) with reduced physical, sensorial or mental capacity, or those lacking experience and knowledge, except if they have been supervised and instructed regarding use of the device by a person responsible for their safety.
- Touching live connections and modifying the electrical and mechanical construction of the oven will put you at risk and may lead to malfunctioning of the oven. Never open the oven casing.
- The oven must be completely disconnected from the mains electricity supply when installation and maintenance work or repairs are being carried out, e.g. when the lighting inside the oven is defect (see the section on "What to do if...?")
Make sure of this by
 - switching off the electrical installation fuses or
 - completely screwing out the electrical installation screw fuses or
 - pulling the power plug (if in place) out of the socket.When doing so, do not pull on the mains supply cable, but on the power plug.

2.3. Oven

- Unplug your oven if it malfunctions.
- If the glass is broken, split or cracked: switch the hob off immediately, disconnect it from the power supply and contact our Customer Service or your specialised dealer.
- Do NOT open the appliance yourself.
- Repairs to appliances must be carried out by qualified technicians.
- The oven must always be operated with the door closed.
- The manufacturer takes no responsibility for any use of the oven other than for the home preparation of food.
- Only use the oven after it has been installed inside the kitchen unit.
- Do not store oil, fats or inflammable materials inside the oven. This may be dangerous if the oven is turned on.
- Do not lean or sit on the open oven door. You could damage it, as well as endangering your safety.
- In order to cook food in the oven, place the tray or grid shelf supplied with it over the shelf runners inside the oven cavity. The tray and grid shelf have a system to make their partial outward movement easy for food handling.
- Do not place containers or food on the bottom surface of the oven. Always use the trays and grid.

- Do not pour water on the bottom surface of the oven when in use; this may damage the enamel.
- Open the oven door as little as possible during cooking. This will reduce power consumption.
- Use protective oven gloves when performing operations inside the oven.
- It is normal for condensation to occur on the oven door when cooking dishes with a high liquid content.
- When the oven is in use, it becomes hot. When the casing heats up, the cooling fan will switch on to cool the casing down. The cooling fan will operate until the casing has cooled down, i.e. also when the appliance has been switched off. The noise made by the fan when it is in operation is normal; it does not indicate any malfunctioning.

2.4. For persons

- These appliances may be used by children aged 8 years and over and by persons with physical, sensory or mental impairments or by persons who lack experience and/or know-how, provided they are supervised or have been instructed in the safe use of the appliance and have understood the risks relating to the appliance. Children may not play with the appliance. Cleaning and maintenance by the user may only be carried out by children when they are supervised.
- The surfaces of the heating and cooking zones become hot during use. Keep small children away at all times.

2.5. Before using the first time

- Remove packaging.
- Be certain your appliance is properly installed and grounded by qualified technician. The manufacturer cannot be held responsible for damages caused by improper installation and electrical connection of this oven. The oven should not be operated until it has been properly installed within cabinetry.
- This appliance may only be used for the standard baking and roasting of food in a household; it is not intended for commercial use.
- The appliance may not be modified.
- Safety is only guaranteed if the appliance is connected to a protective conductor which complies with currently valid regulations.

- The appliance may not be connected to the power supply with an extension cable.
- The appliance may not be installed above a dishwasher or a tumble dryer: the steam released by these appliances may damage the electronic unit.
- Also take note of the instructions on cleaning and care before using your appliance for the first time.

2.6. Environmental Protection



- Remove packaging and the old appliance
- Remove packaging and recycle in an environmentally-friendly way.
- In Germany, the transport packaging is returned to the store where the appliance has been purchased. By returning the packaging material, raw materials are saved and also fewer waste products are generated. Old appliances still contain valuable material. Leave your old appliance at a collection point for valuable materials. Old appliances must be rendered inoperative before disposing of them in order to prevent improper use.

2.7. Energy information

Tested to comply with the requirements of the 66/2014 (Eco-Design) and 65/2014 (Energy Labelling) regulations in accordance with Regulation EN 60350-1.

Energy consumption measurements taken under different conditions may give different values from those indicated for your oven. Consult the User's guide accompanying this manual to learn about the energy consumption of your oven

2.8. Intended purpose.

- This oven is intended for household use and in household-like installation environments.
- This oven is not suitable for outdoor use.
- This oven is only to be used as a domestic household appliance for roasting, baking, grilling, cooking, defrosting, preserving and drying foods. No other type of application is permissible.

Safety Instructions and Warnings

- This appliance is not for use by persons (including children) with reduced physical, sensorial or mental capacity, or those lacking experience and knowledge, except if they have been supervised and instructed regarding use of the device by a person responsible for their safety. These persons may only operate the oven unattended if it has been explained to them in such a manner that they are able to operate it safely. They need to recognise and understand the potential risks that operation entails.
- The oven may only be used if it has been installed in a suitable unit. Only use the oven as described in these instructions for use. Any other use is not considered to be intended and may result in damage to material or even injury to persons. The manufacturer cannot be held responsible for damages caused by improper use of this oven.
- The oven is only intended for use in private households. It may not be used for commercial purposes.
- The oven is not suitable for heating a room.
- The lamp in the oven has only been provided for lighting up the interior of the oven; it does not serve as room lighting.
- The oven door may not be used as a support, seat or step.



The appliance may only be used for its intended purpose!

3. Cleaning and care

You should carefully read this chapter before you use your appliance the first time. If cleaned correctly and looked after regularly the appliance will remain beautiful and clean for many years. The following tips will help you to clean and care for your oven's various surfaces gently but thoroughly.

3.1. For all surfaces



DANGER TO LIFE!

Do not use steam and/or pressure cleaning devices on the oven! The appliance could become damaged and may create a situation where there is danger of death.



RISK OF BURNING!

Leave the appliance to cool until you can touch it with your hand before cleaning it.

- Clean the oven each time you use it. Stains or baked-on food that have not been removed may burn the next time the appliance heats up. Often, these types of stains or dirt cannot be removed without leaving marks.

To clean an oven that is not very dirty, use a damp cloth, a soft brush or a soft sponge and a weak solution of detergent and warm water. Rinse with cold water so that there is no detergent left which might decolour the surface or cause more stains. Dry with a cloth immediately after. Here are some instructions for more difficult-to-remove stains concerning the different surfaces and elements. VSR 0-FIX-C is ideal for cleaning glass-ceramic, enamel and the surface of the inside of the door. This cleaning powder can be purchased from the Küppersbusch Customer service.

- The shelf runners may be removed for cleaning. Reinstall them correctly and never use the oven without the shelf runners installed.
- Clean the outside surfaces of the oven and its accessories with lukewarm soapy water or a mild detergent. Take care with rust-free and varnished surfaces and only use sponges or cloths that do not scratch.



NEVER CLEAN WITH

- **aggressive or bleach-based cleaning agents that contain active oxygen, chlorine or other caustic substances.**
- **abrasive cleaning or scouring agents, such as steel wool, soap-impregnated steel wool, stiff brushes, metal or plastic sponges or any similar cleaners with an abrasive surface.**

3.1.1 *Removing dried deposits*

Thick deposits must be soaked to soften them beforehand. This is best done with a wet cloth. It will then be easier to remove the deposits.

Over time, certain types of food such as tomatoes, vinegar and salt-baked dishes may cause the enamel to change colour. This is normal and does not affect the functioning of the oven. Do not try to remove these stains using aggressive methods such as those described, as this could cause permanent damage to the surface.

Using a cleaning scraper



CAUTION! RISK OF CUTS!

The blade of the cleaning scraper is very sharp!

Always hold the cleaning scraper flat to the surface and push the grease away from you.

Do not scrape with the corners of the cleaning scraper; handle it carefully to ensure that no sealing is damaged.

3.1.2 *Suggestions on the use of oven sprays*

The manufacturer's instructions must always be observed.



CAUTION!

Do not spray into the fan opening on the back. The ökotherm® catalyst will be destroyed if oven spray is used.

Oven sprays will damage aluminium and varnished and plastic surfaces.

For environmental reasons you should not use oven spray at all. If you nevertheless want to use it, only spray it in the oven interior and on enamel baking trays.

Chromium-plated oven trimmings

Door front and handle with chromium-plated, black trimming

- Limescaling, grease and starch deposits must be removed immediately; stains will result if they are not.
- These models are very sensitive to scratches and oven spray will damage them. Do not use cleaning scrapers, pot scourers or hard-fibre sponges.



Use a cloth or a soft sponge and rinse only with warm water and a little detergent.

Stainless steel

Stainless steel door front and control panel



Use a cloth or a soft sponge and rinse only with warm water and a little detergent.



CAUTION!

Stainless steel scratches very easily! Do not use a scraper!

Limescaling, grease and starch deposits must be removed immediately; stains will result if they are not.



We recommend that you clean stainless steel surfaces with a standard cleaning agent for stainless steel once a week. This will create a protective film, protecting the stainless steel from becoming discoloured.

Enamel

Oven interior, front, baking sheets

It is possible to use plastic sponges with a pot scouring part. However, some products have grit in the pot scouring part and this causes scratching. It is recommended that you test your product at a point that is not clearly visible.



A cleaning scraper is ideal for removing stubborn dirt. We recommend VSR 0-FIX-C for a thorough clean. Oven spray can also be used.

3.2. *Cleaning the oven door* (*not possible for ovens with a microwave function)

Do not use any metal pot scourers, wire brushes, scouring powder or abrasives to clean the oven door, since this may result in the surface becoming scratched or the glass breaking. Clean the outside of the door and its accessories with lukewarm soapy water or a mild detergent. Corrosion-resistant surfaces must be treated with care. Use only sponges or cloths that do not cause scratching.

3.2.1 *Door glass*

Door interior – coated glass



CAUTION!

If possible do not use any oven spray, since its regular use can destroy the coating on the glass.



A cleaning scraper is ideal for removing stubborn dirt. We recommend VSR 0-FIX-C for a thorough clean.

Remove residual dirt from the oven sealing.

Door front, control panel



Use a cloth or a soft sponge and warm water and a little detergent to clean the door front. Glass cleaner may also be used.

3.2.2 *Door sealing*

Clean the sealing regularly to eliminate all traces of fat or food. This will prevent the seal from becoming damaged and breaking during subsequent cooking operations.

It is advisable to clean this sealing without removing it.

3.3. Pyrolytic self-cleaning of the oven (depending on the model)

This function involves a pyrolytic cleaning process which applies high temperatures in the oven interior to trigger a process of oxidation and carbonisation process on the grease contamination.

After the pyrolytic cleaning process has been completed, all you need to do is remove the ash generated during the process with a damp cloth. Places in the interior that are difficult to access are cleaned with a non-metallic pot scourer in order not to damage the enamel coating.

The oven has 3 pyrolytic programs which run for 60, 90 and 120 minutes respectively. Choose the running time depending on how dirty the interior of the oven is. The dirtier the oven, the longer the program should take. It is not necessary to run the pyrolytic cleaning process every time you use the oven for baking or roasting. We recommend running the pyrolytic program every 4.5 times the oven is used for baking or roasting, depending on how dirty the interior of the oven is. The interior lighting in the oven will remain switched off during a cleaning cycle.







VERY IMPORTANT!

Remove all the accessories and dishes from the oven, including the guide rails for the baking trays and/or the glide-out shelves for the pyrolytic self-cleaning function.

Remove food rests and excessive dirt since they may ignite, giving rise to danger during the self-cleaning process.

4. Before using the first time

There may be traces of fat and other substances in the oven as a result of the manufacturing process. Proceed as follows to remove them:

- Remove all the packaging including any protective plastic film that may have been used.
- Connect the oven and allow it to operate using function  /  or  /  at 200 °C for an hour.
- Allow the oven to cool down and open the door. This will ventilate the oven and no smells will remain in the inside.
- Clean the oven and its accessories after it has cooled down.

Smoke and odours will be generated during initial operation, so make sure that the kitchen is well ventilated.

4.1. Important instructions

- Do not cover the bottom of the oven with aluminium foil as this may affect cooking performance and damage the enamel inside the oven and the interior of your kitchen unit. Do not pour water on the bottom surface when in use; this may damage the enamel.
- It is normal for condensation to occur on the oven door when cooking dishes with a high liquid content.
- When closing the oven door during cooking, the sound of the air inside it can be heard. This effect is normal due to the pressure exerted by the door when it is closed, guaranteeing the sealing of the cavity.
- Do not place containers or food on the bottom surface of the oven. Always use the trays and racks supplied with the oven.
- To prepare yoghurt, place the jars on the oven floor.
- To cook any other food, insert the tray or rack into the runners inside the oven.

Between the two rails of the side supports or on any of the extractable runners, if the oven has them.

- Switch off the electrical installation fuses or
- The rack and some of the trays have retention grooves to prevent them from accidentally being removed. Place these grooves towards the back of the oven, facing downwards.
- The surface of the rack on which the container will rest must be below the side rails; This prevents the container from accidentally sliding.
- The trays have a tab at the front to facilitate their removal. Place the tray with the tab facing towards the outside of the oven.

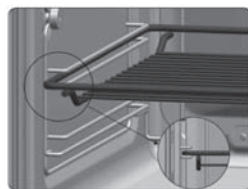
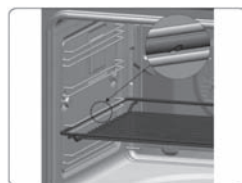

5. Accessories

Some oven models have a glide-out shelves kit accessory.



IMPORTANT!

The glide-out shelves must be placed at height 2, starting from below.

To assemble the glide-out shelves on the chrome-plated supports, proceed as follows:

5.1. *Glide-out shelves with folding clip*

- Remove the protective film.
- Hook the large clips on the upper rail and extend the runner until it hooks on the small clips on the lower rail.

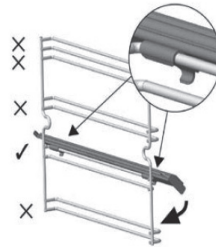

- You will hear a "click" when the glide-out shelf is correctly secured.
- The notch to fix the tray/support must remain at the front part of the oven.

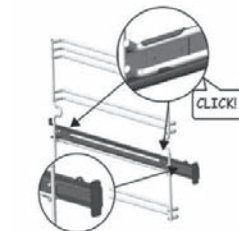

5.2. Glide-out shelves with direct clip



IMPORTANT!

The single extraction shelf must be placed at heights 1, 2 and 3 starting from below.
The double extraction shelves must be placed at heights 1, 2 and 3 starting from below.
In 45 cm ovens, the glide-out shelves are positioned at height 1.

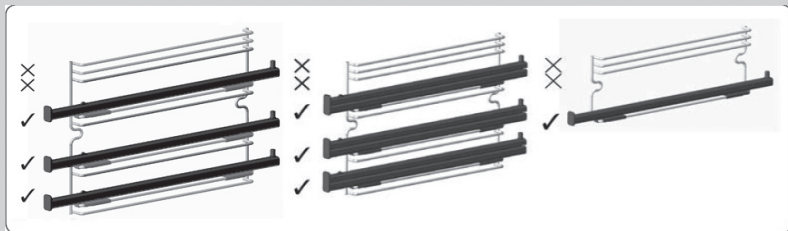

- Hook the clip on the top rail at the desired level.
- You will hear a "click" when the glide-out shelf is correctly secured.
- The notch to fix the tray/support must remain at the front part of the oven.

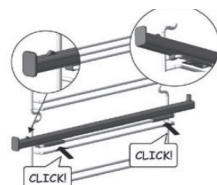

CAUTION!

Disconnect the appliance from the mains power supply before any operation.

5.3. *Cleaning the oven accessories*

Clean the outside of the oven and accessories with warm soapy water or with a mild detergent. Take care with rust-free and varnished surfaces and only use sponges or cloths that do not scratch.



CAUTION!

The telescopic glide-out shelves must not be placed in the dishwasher. This will remove the fat that enables them to slide and the runners will become blocked, making them useless.

6. *Maintenance work*

6.1. *Replacing the oven lamp*



IMPORTANT!

Before you replace the lamp, make sure that the oven has been disconnected from the mains.

The replacement bulb must withstand temperatures up to 300 °C. They can be ordered from our technical Customer Service.

6.1.1 *Changing the side bulb*

- Remove the chrome-plated runners and/or glide-out shelves by removing the screw nuts (A).

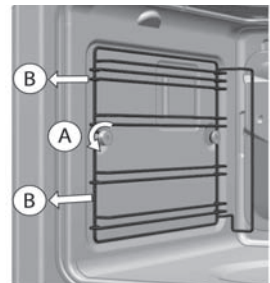

Maintenance work

- Use a tool to take out the glass cover of the lamp mounting.
- Replace the lamp.
- Attach the glass cover again, making sure it is properly positioned.

The replacement lamp must be resistant to temperatures of up to 300°C. They can be ordered from our technical Customer Service.



6.1.2 Changing the upper bulb

- Unscrew the glass cover of the bulb-holder.
- Replace the bulb and reassemble the glass cover.

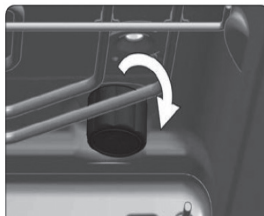

6.1.3 Changing the LED lamp

Call the Technical Assistance Service Department

6.2. Removing the oven door

(not possible for ovens with a microwave function)

For easy cleaning, the door can be dismantled. To do this, follow the instructions for the type of door your oven has.

6.2.1 Door with hinge on body

Dismantling the door

- Open the oven door as far as it will go.
- Block the hinge by turning the latches.
- Swing the hinge locks down towards you.
- Close the door to the locked position.
- Hold the door with both hands holding on to both sides,

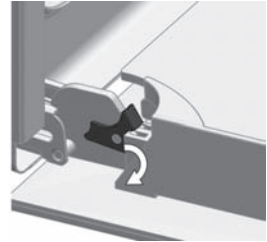

Assembling the door

- Hold the door with both hands at the lower part of the sides, insert the hinge arms into their housings and let the door fall as far as it will go.
- Open the oven door fully.
- Turn the latches back to their original position.



CAUTION!

Make sure the door is inserted completely by turning the latches, because otherwise it could block.



If the latches are hard to turn, use a flat tool to turn them.

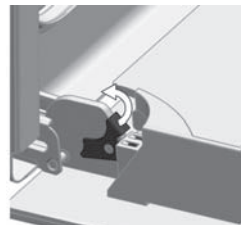

6.2.2 Door with hinge on door

Dismantling the door

- Open the oven door as far as it will go.
- Block the hinge by turning the latches.
- Swing the hinge locks down towards you.
- Close the door to the locked position.
- Hold the door with both hands holding on to both sides, lift up and pull out the oven door until the hinges are fully detached.
- To assemble the door, carry out the steps in the reverse order.



Assembling the door

- Hold the door with both hands at the lower part of the sides, insert the hinge arms into their housings and let the door fall as far as it will go.
- Open the oven door fully.
- Turn the latches back to their original position.

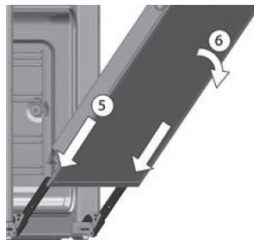

ATTENTION!

Make sure the door is inserted completely by turning the latches, because otherwise it could block.



If the latches are hard to turn, use a flat tool to turn them.

6.3. Dismantling/assembling the interior glass of the door

Depending on the model, your oven may have 2, 3 or 4 panes of glass. Follow the instructions for the type of door your oven has.

Assembling

Depending on the model, your oven may have a completely closed stainless steel door. With this door it isn't possible to remove the panes of glass.



ATTENTION!

If dismantling the glass panes with the door fitted in the oven, always do it with the hinge in the locked position. If not, the door will close and the unmounted glass panes could break and cause injury.



To prevent this, dismantle the glass panes with the door removed, following the instructions in the previous section.

- Using your fingers, press the buttons located at the top of both sides of the oven door.



- Keep them pressed and pull on the plastic seal above the door.
- Remove the glass panes from the door. Clean them with a glass cleaner or soap and water and a soft cloth.

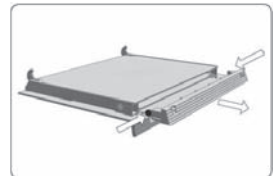

ATTENTION!

Pay attention to the order and position of the glass panes when removing them as they must be reassembled in the same order and position when you have finished cleaning them.

- Once clean, insert pane no. 3 into the same position so that the TERMOGLASS indication printed on it is visible as shown in the figure.



- In pyrolytic ovens, the TERMOGLASS indication on panes numbers 3 and 4 must be visible as shown.
- Insert pane no. 2 with the printed part facing toward the inner side of the door.
- Reattach the top seal of the door, making sure that the side tabs fit into their housings.



ATTENTION!

Never switch the oven on if any of the glass panes on the door is missing.



6.4. Dismantling/assembling the shelf runners

12 rack levels are available in the side racks. Rack levels are counted from the top to the bottom from 1 to 12. Rack level 1 is the lowest rack level.

Dismantling

- Open the oven door as far as it will go.
- Take the accessories out of the oven.
- Completely loosen the nut at the front of the fastening element (A), pull the supports forward (B) and remove them.
- Removing the side racks

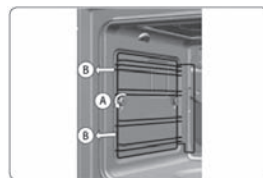

- Insert the rear notch into the rear fastening nut.
- Fix the front fastening nut (C) in the front notch of the support.
- Secure the support with the nut (D) and turn until it is fully adjusted (E).

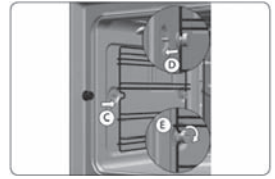

6.5. Dismantling the rear wall



First of all remove the side runner to remove the rear wall, following the instructions in the previous section.

- Remove the lower four screws (1) and then the top screw (B).

To assemble rear wall, carry out the steps in the reverse order.

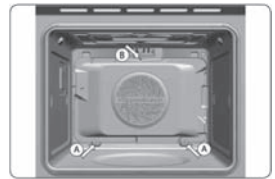

ATTENTION!

For your own safety: Never use the oven without the rear wall!

Ovens with a folding grill

To clean the top part of the oven.

- Take the accessories out of the oven.
- Wait until the oven is cold.
- Push the rail of the grill element (A) with both hands towards the back of the oven, to release it from the upper fastening nut (B).

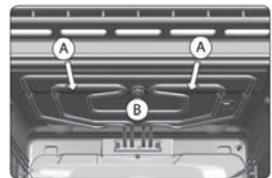

- Let the element fall and clean the top part of the oven.
- Then put the grill element back in place in its original position and proceed in the reverse order.



7. Overview of your oven

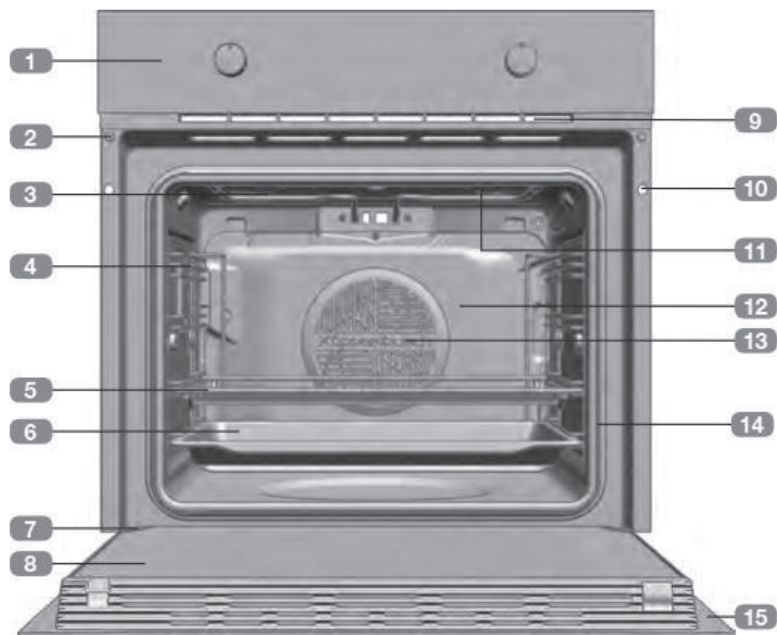

Optional accessories:

Pizza stone

(accessory no. 145)

Oven grid

(accessory no. 124)

Baking tray

(accessory no. 541)

Cake tin (accessory no. 543)

Standard accessories:

Oven grid

Enamel baking tray

Enamel drip pan

- 1 Control panel
- 2 Door lock (only for pyrolytic models)
- 3 Grill element
- 4 Rack levels
- 5 Gridiron
- 6 Baking tray
- 7 Hinge
- 8 Inner glass
- 9 Cooling air exit
- 10 Unit mounting
- 11 Lamp
- 12 Rear wall
- 13 Hot-air fan
- 14 Oven sealing
- 15 Oven door

7.1. Control panel - sensor keys and displays



- 1 ON/OFF sensor**
 1 With this sensor you can switch off an on your appliance-



- 2 Sensor Automatic programme**
 2 With this sensor you can select the automatic programmes.



- 3 Memory sensor ***
 3 With this sensor you have access to the saved programme.



- 3 Sensor Steam cooking functions***
 3 With this sensor you can select the Steam cooking functions.



- 3 Sensor Microwave***
 3 With this sensor you call up the microwave functions or switch on the additional microwave function.



- 3 Sensor Pyrolytic***
 3 With this sensor you can select the pyrolytic functions.



- 4 Sensor Time settings / Timer**
 4 With this sensor you have access to the menu Time setting.



- 5 Light sensor**
 5 With this sensor you can switch off an on the lighting of the interior of the oven.



- 6 Sensor back**
 6 With this sensor you turn to the in a previous step.



- 7 Sensor OK for selection/confirmation**
 7 With this sensor you confirm your selection or start a process.



- 8 Left control switch**
 8 ...to select functions or programmes



- 9 Right control switch**
 9 ...to select settings.

* depending on the model



8. Basic settings

8.1. Setting the clock

The clock must be set before the oven is used and whenever power has been disconnected to the appliance. In such cases «12.00» will blink in the display.

When the oven is switched on, 12:00 will blink in the display.

- Turn the left selection switch to select an hour.
- Turn the right selection switch to select the minutes.

- Then confirm by pressing . You will then need to select the clock display. Use the right switch to choose between the standard and the retro clock display.
- Then confirm by pressing .

- An acoustic signal will sound and the oven will switch to the standby mode. The time that has been set will be shown.

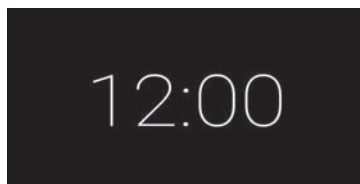
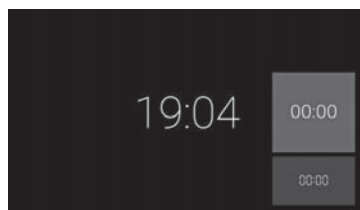
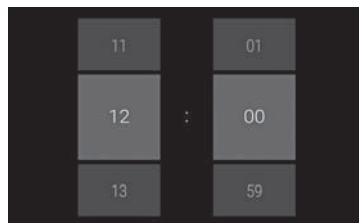

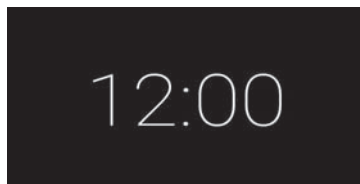

Should you wish to change the time:

With the oven switched off, press the  symbol for 3 seconds and wait until the time setting is shown.

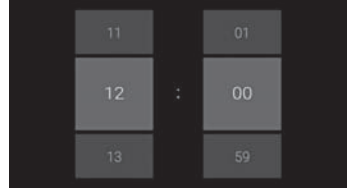

- Turn the left selection switch to select an hour.
- Turn the right selection switch to select the minutes.
- Then confirm by pressing .



- You can then choose between the standard and the retro clock. Turn the right switch and then confirm with .



This will be followed by an acoustic signal as confirmation.
You will return to the standby display.

The selected time will be shown.

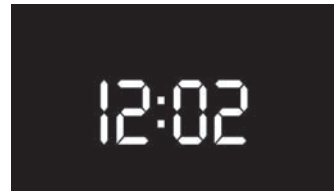

9. Roasting and baking charts

Guidelines for baking

- The material of your baking tins also plays a role in baking. Dark baking tins, which transmit heat direct to food being cooked, are ideal.
- Baking times may differ slightly due to differences in the type of ingredients used. Testing your cake towards the end of the cooking time with a wooden skewer is ideal. If no dough sticks to the skewer, the cake will be ready.
- When cakes with a moist fruit topping are being baked, the development of humidity is particularly high. Never bake more than two of this kind of cake at the same time.
- If you are baking several cakes in baking tins at the same time, add about 5 to -10 minutes for each additional tray used.

Roasting and baking charts

Guidelines for baking							
Operating mode	Hot air		Top/Bottom heat		Pizza mode Hot air convection bottom heat		Baking time in minutes
	Rack level	Temp. in °C	Rack level	Temp. in °C	Rack level	Temp. in °C	
Cakes							
Cake mixture							
Gugelhupf	2	170	2	170-190			60-70
Tin cake	2	170	2	170-190			50-70
Madeira cake	2	160	2	160-180			60-70
Flan bases	2	170	2	170-190			20-30
Muffins	2	160-170	2	170-180			20-25
Flat cakes							
with a dry topping	2	160-170	2	180-200			20-35
with a moist topping	1-2	160-170	1-2	170-180	3	160-170	35-50
Kneaded dough							
Flan bases	2	170-180	2	180-200			25-35
Cheese cake	2	150-160	1-2	160-170			70-80
Small biscuits	2	170	2	180-200			15-30
Flat cakes							
with a dry topping	2	160-170	2	180-190			25-35
with a moist topping	1-2	160-170	1-2	170-180	2	160-170	30-50
Yeast dough							
Gugelhupf	2	150-160	2	175-180			40-65
Yeast cake	2	150-160	2	175-180			40-50
Rich sweet bread (preheated)	2	150-160	2	175-180			50-70
Small biscuits	2	140-150	2	180-200			15-30
Flat cakes							

with a dry topping	2	150-160	2	180-190			30-40
with a moist topping	1-2	160-170	1-2	170-180	3	160-170	30-50
Sponge dough							
Gateaux and flans (preheat)	2	150-160	2	175-180			30-40
Rolls (preheat)	2	170-180	2	180-200			15-25
Egg white baking							
Meringue	2	80-90	2	100-120			80-120
Cinnamon stars	2	100-120	2	120-140			20-40
Macarons	2	100-120	2	120-140			20-50
Other doughs							
Puff pastry	2	170-180	2	190-210			15-30
Puff pastry made with leavened dough	2	170-180	2	190-210			30-40
Puff pastry made with curd cheese	2	160-180	2	180-200			30-40
Choux pastry	2	170-180	2	190-210			30-40
Dough made with curd cheese and oil	2	150-160	2	170-180			30-40
Honey cake	2	140-150	2	170-180			20-35
Bread and pizza							
Sour dough (preheat: 230°C)	2	180	2	180			50-70
prebake: 10 min. -230°C)							
Bread made with yeast/white bread (preheat)	2	180	1 or 2	200			30-60
Pretzels (preheat: 230°C)	2	200	2	220			15-20
Pizza (preheat: 250°C)					1	220	8-12

9.1. Guidelines for roasting

- Meat that has been well hung is best suited for roasting.
- Make criss-cross cuts on the outer layers of fat on the meat (e.g. knuckle).
- Roasts can all be cooked with or without the addition of fat.
- Roast the meat on the grid with the drip pan underneath.
- Coat poultry, such as chicken, goose or turkey, with a marinade made of oil, salt and paprika powder. This means that meat does not have to be basted while it is roasting.

Tips for more precise results

The cooking progress, particularly of large joints, is not always easy to judge from the outside. Chefs de cuisine and hobby cooks therefore use a roasting thermometer. This provides reliable information about the core temperature and thus also about how far the meat has been roasted.

Guidelines for roasting								
Operating mode	Hot air		Top/Bottom heat		Hot air convection bottom heat			
Preferred settings have a grey background	Rack level	Temp. in °C	Rack level	Temp. in °C	Rack level	Temp. in °C	Weight of meat	Baking time in minutes
Type of meat								
Pork								
Roast pork	2	170	2	170-190	2	160-180	2,000	120
Pork shoulder	2	180	2	180-200	2	170-190	1,200	120
Pork fillet	2	180	2	180-200	2	170-190	1,000	45
Beef								
Joint of beef	2	170	2	170-190			2,000	150
Roastbeef	2	160 / 90*	2	160 / 100*			1,500	30

Beef fillet	2	160 / 90*	2	160 / 100*			1,200	30
Veal / lamb								
Lamb roast	2	160	2	170-180			1,000	140
Roast veal	2	160	2	170-180			1,000	90
Steak								
Rump steak (browned beforehand)	2	120**	2	120**			300	10
T-bone steak (browned beforehand)	2	180**	2	180-200**			1,000	6
Poultry								
Chicken	2	180	2	180-200	2	180-200	1,000	60
Duck	2	170	2	170-190	2	170-190	1,500	75
Goose	1 or 2	160	1 or 2	170-190	1 or 2	170-190	3,000	120
Turkey	1 or 2	160	1 or 2	170-190	1 or 2	170-190	5,000	180
Fish								
Whole fish	2	200	2	200-220			1,000	35

9.2. Guidelines for grilling

- The grill should be pre-heated for approx. 5 minutes before being used.
- Put the meat that has been prepared onto the grid so that the heat from the grill body has a direct effect. A clearance of 3 cm must be maintained.
- Always place the drip pan under the food in order to collect dripping meat juices.
- Food grilled on the grid will need to be turned.
- The first side will need to be grilled a little longer than the second side.
- Since the food generally differs in shape, thickness and consistency, you should check now and then on whether or not the meat has been cooked as required. Specified grilling times can thus only serve as a guide.

Tips for ideal results

Also use a roasting thermometer for low-temperature cooking. This provides reliable information about the core temperature inside the meat and thus also about how far the meat has been roasted.

Guidelines for grilling					
Operating mode		Grill		Large-surface grill	
	Rack level	1 side	2 side	1 side	2 side
Type of meat					
Pork					
Pork chop	4	10-12	8-10	14-15	8-10
Belly	4	12-15	8-10	16-18	10-12
Pork fillet	4	10-12	8-10	14-16	10-12
Frying sausages	4	8-10	6-8	12-15	10-12
Fried sausage coils	4	10-12	8-10	10-14	9-11
Kebab	3-4	9-11	7-8	15-20	10-12
Beef					
Beef fillet, rare	4	6-7	5-6	8-10	6-7
Beef fillet, medium	4	7-9	6-7	9-11	6-9

Veal / lamb					
Lamb chop	4	7-8	6-7	9-11	6-9
Veal steak	4	8-10	7-8	10-12	8-9
Poultry					
Chicken drumsticks	3	15-18	10-12	17-20	11-14
Chicken halves	3	18-20	10-12	22-24	12-15
Fish					
Fish fillet	4	6-7	4-5	10-12	7-8
Whole fish	3	5-7	4-6	8-11	7-10
Toast					
Toast	3	2-3	2-3	4-6	3-4
Toast with a topping	3	6-8		10-12	

9.3. Recommended food probe temperatures

Recommended food probe temperatures			
	Core temperatures in °C		
	Rare	Medium	well done
Type of meat			
Pork			
Pork fillet		63	65
Roast pork / jam		68-70	75
Knuckle			80-85
Cutlet on the bone			75-80

Roasting and baking charts

Shoulder			95
Gammon		55-62	64-68
Meat loaf			75
Beef			
Beef fillet	38-55	58-65	from 65
Roastbeef	38-55	55-60	from 65
Roulades			70
Joint of beef			85-90
Boiled beef			90
Entrecote		55-58	
Veal			
Knuckle			80-85
Roasting			64-74
Breast			75-78
Saddle		65-70	
Shoulder			75-80
Sirloin		60	
Lamb			
Lamb			79-85
Leg of lamb		60	70-72
Lamb chop		55	
Saddle of lamb		60-62	68
Rack of lamb		55	
Game			
Wild boar fillet		60-63	
Roast wild boar			75-78
Leg of wild boar			75
Saddle of roe venison		50-60	
Roast roe venison		65	
Saddle of deer venison		54-60	

Roast deer venison		62	75
Toast with a topping	3	6-8	
Poultry			
Chicken			80-90
Duck			80-90
Breast of duck		62-65	
Goose		75-80	90-92
Turkey			80-90
Fish			
Salmon		57	60
Pike		58	60
Zander		58	60
Tuna		55	58
Redfish		55	60
Cod		54	60
Trout		54	60
Yellow mackerel		54	60

9.4. Low-temperature cooking guidelines

Low-temperature cooking guidelines				
	Weight in g	Browning time in minutes	Cooking time in minutes (core temperature as an alternative)	Cooking temperature in °C (oven setting)
Type of meat				
Pork				
Pork fillet	400-600	5	60-90	85
Roast pork / jam	1000-1500	10-12	230-250	85
Loin	1000-1500	10-12	120-150	85
Piece of rib / cutlet	800-1000	8-10	120-140	85

Roasting and baking charts

Beef				
Beef fillet	700-1200	5-9	100-140	80
Roastbeef	700-1800	10-12	180-120	70
Point steak	1500-1800	10-15	150-200	80
Nut	1500-2000	10-12	200-230	80
Entrecote	1500-1800	10-12	150-180	80
Veal				
Fillet steak	500-800	5-6	90-110	85
Nut	1500-1800	10-12	140-160	85
Saddle	1000-1500	8-10	110-120	85
Lamb				
Leg of lamb	2000-2500	10-12	200-250	80
Saddle fillet	400-600	3-5	60-80	80
Poultry				
Breast of duck	400-600	4-5	70-80	85
Turkey breast	400-600	3-4	50-60	85

10. Oven functions

The functions all depend on the model in question.

10.1. Cooking functions

Top / bottom heat

Heat from the top and the bottom ensures even baking results for food placed on one level. Ideal for baking delicate cakes and gateaus, such as yeast dough, cheesecake, etc.

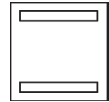

Ökotherm hot air

The fan distributes the heat generated by the ring heating element at the back of the oven. The heat spread evenly throughout the oven makes it possible to cook evenly at several levels without the flavour or odour being transmitted.



Top / bottom heat with hot air

The fan distributes the heat generated by the heating elements at the top and bottom evenly throughout the oven. Ideal for biscuits and roasts.



Ökotherm pizza setting

A combination of bottom heat and hot air is ideal for baking crispy bases with a moist topping. Perfect for fresh pizza, biscuits or cakes with a fruit topping and pastries and pies.



Bottom heat

With heat generated only at the bottom, this mode ensures that bases or especially crispy and/or that they are browned better on the bottom. Ideal for very moist fruit cakes and for blind-baking cake bases.

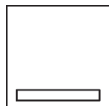

Top heat

The heat generated by the top heating element is ideal for gratinating and browning dishes.

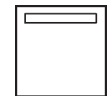

ECO

ECO makes it possible to cook dishes with a lower energy consumption than usual. In order to save on energy, the oven switches off automatically a few minutes before the end of the cooking time and uses the remaining heat in the oven to cook food through.



Ökotherm intensive hot air

The top heat switched on in addition to heating the oven up with hot air ensures a delicious crust and intensive browning. Ideal for oven-baked potatoes, roasts and for gratinating dishes.



Grill / bottom heat

Bottom heat in combination with the grill from the top. This mode is ideal for cooking meat. It provides crispy results.

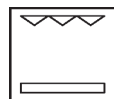

Large-surface grill

Perfect for cooking large quantities of food to be grilled, such as fish or meat.

This enables larger surfaces to be gratinated than with a grill. And the gratinating power is higher so that food browns quicker.

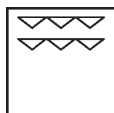

Grill

Gratinating and browning. The small grill saves energy when small quantities of food is cooked. Ideal for small quantities of fish and meat. Makes it possible to brown the outer layer without influencing the inside of the food to be cooked.

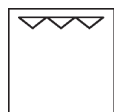

Fan-assisted grilling

The fan distributes the heat generated by the grill throughout the oven, thus providing grilled food that has a crust and is juicy inside. Ideal for grilled chicken, duck and roasts.

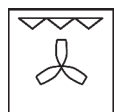

Intensive fan-assisted grilling

This combination of a large-surface grill and a fan ensures that food to be cooked remains juicy inside and that it is beautifully crispy and brown on the outside. Ideal for game and large poultry.

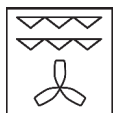

Intensive fan-assisted grilling + bottom heat

This combination of a large-surface grill, bottom heat and a fan ensures that large food portions remain juicy inside and that they are beautifully crispy and brown on the outside. Ideal for stuffed roasts or poultry.

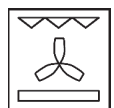

10.2. Special functions

Defrosting

This function serves to gently defrost frozen food.

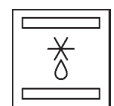

Low-temperature cooking

Food is cooked very gently at low temperatures, which also keep it very juicy. Ideal for beef, pork, lamb, veal and poultry.

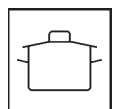

Keeping food warm

Food is kept warm at low temperatures, without continuing to be cooked. Ideal for food that is to be served later on.

**Frozen foods**

The optimal distribution of heat that has only been slightly warmed up in the oven makes this programme ideal for defrosting frozen food.

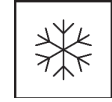
**Warming plates**

Good food just tastes better at the right temperature. This mode heats up plates at a low temperature just before food is served. This prevents it from cooling down so quickly when it is being put onto plates so it can be served hot.

**Gratinating**

This function is ideal for gratinating gratin dishes, oven bakes and soufflés.

**Preserving**

Ideal for preserving foods such as fruit and vegetables.

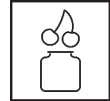
**Dehydrating**

With the dehydrating mode water is extracted from food to extend its shelf life. Most vitamins and minerals are preserved. Dehydrating is ideal in the production of dried fruit, dried meat, fruit purees and dried cod.

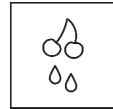
**Baking bread**

This programme is ideal for getting a light crumb texture and a beautifully browned crust.

**Proving**

Best function for allowing dough to rise, for example.

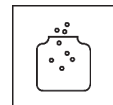
**Yoghurt mode**

Yoghurt cultures feel really good in this mode and your yoghurt will turn out perfect.

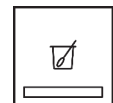

11. Operating the oven



The fan is switched on and off in the case of some programmes, but this is not an indication of a fault.



11.1. Switching on the oven

In order to be able to use your oven for cooking food, you will need to press on the  symbol. If neither a function nor an automatic programme is selected, the oven will switch off again after a few seconds and show the current time of day.

11.2. Switching the oven off

Touch the symbol .

11.3. Selecting one cooking function

- Switch the oven on by touching symbol .
- Turn the left switch to select a cooking function.
- Confirm your setting by turning the right switch or by pressing  drücken.
- Turn the right switch in order to select a garden temperature and confirm with .

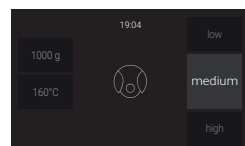
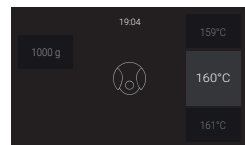
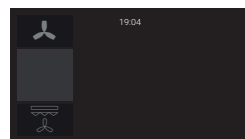
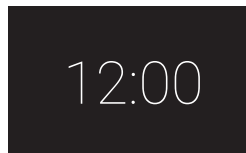

You will access the settings view. You can also set the cooking time or the finish time. (See 11.6.1 on page 50 and 11.6.3 on page 52).

- To confirm the settings, press . The cooking process will be commenced.

11.4. Changing a setting during the cooking process

If you wish to change a cooking setting during the cooking process, turn the left switch; turn the right switch if you wish to change the cooking temperature. Then following the instructions above. During the cooking process, press symbol , to adjust the cooking time or the finishing time.







INFO

Changes must all be actively confirmed with OK, if they are not the screen will return to the old display after 8 seconds and the new settings will not be saved.

11.5. Automatic programme

11.5.1 Selecting an automatic programme

- Switch the oven on by touching symbol .
- Then touch the symbol for programmes  to call up an automatic programme.
- Turn the left switch to select an automatic programme. To confirm, press  or turn the right switch.
- Turn the right switch again in order to select the weight and to confirm press .

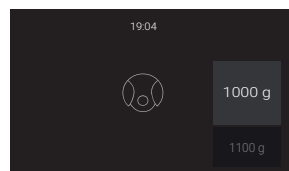
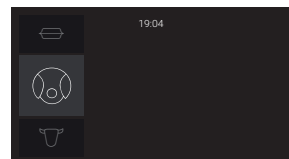
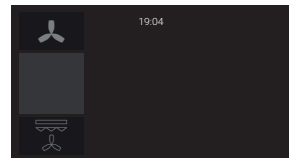
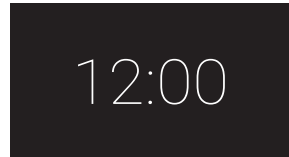

- Turn the right switch again in order to select the cooking temperature and to confirm press **OK**.

(This setting depends on the programme and is not available in some programmes.)

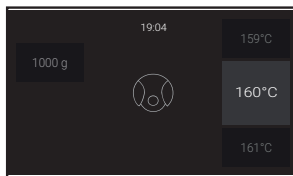

- Turn the right switch again in order to select the cooking setting and to confirm press **OK**.

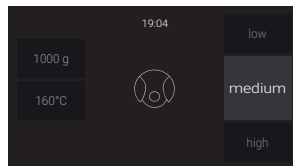

You will access the settings view. Cooking times are automatically calculated. You can also set finish times.

(See 11.6.1 and 11.6.3).

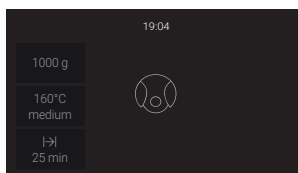

- To confirm the settings, press **OK**.

The oven will commence the cooking process.

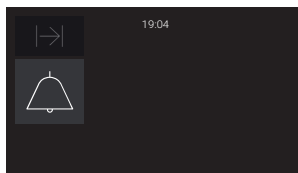

11.5.2 Important information about cooking with programmes



When a programme is activated and on the basis of the weight indicated, the temperature and the cooking setting, the oven automatically calculates the temperature and time needed for cooking the food. The temperature can, however, be changed. If expressly no other information follows, the cooking time refers to a cooking time **without** pre-heating.

This is why it is **very important to select the right weight of the food to be cooked**, so that it can be appropriately prepared.

For the **roasting programmes**, after a specific time has lapsed, the oven will indicate that the roast should be turned. To do so, the oven emits an acoustic signal for a certain length of time. The symbol  will appear on the display until the roast has been turned. If you do not turn the roast, the oven will automatically continue operating the programmed method of cooking after a few minutes.



The programmes for white bread, black bread and thin and thick pizza dough are operated with pre-heating with the oven empty, i.e. before the food to be cooked is put into the oven. This means that the oven reaches the right temperature to be able to best cook the food.

The procedure for cooking with these programmes is as follows:

- First of all select the programme. The cooking process will then begin.



You may only put the food into the oven when the green progress bar appears.





- For automatic programmes, which require a pre-heating phase, an orange progress bar will appear and show the current cooking temperature. This bar will be visible until the temperature that has been set is reached.
- As soon as the temperature specified for the programme has been reached the oven will emit an acoustic signal. You can now put the food into the oven.
- The cooking process starts when the door is opened and closed, pressing the  symbol or automatically after a few minutes.
- Cooking according to the selected programme follows. An acoustic signal will sound after the cooking time has expired. Press any button to stop the acoustic signal and switch off the oven. Otherwise the oven switches itself off automatically after 7 minutes.

11.5.3 Changing the weight of the food

If you wish to change the weight of the dish to be cooked, you can automatically change the duration and temperature corresponding to the selected programme.

Proceed as follows to change the weight:

- Touch the symbol .
- Then press the  symbol several times until you reach weight setting.
- Turn the right switch in order to change the weight and to confirm press .

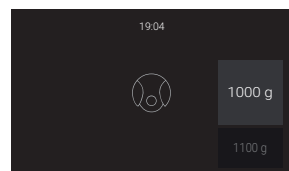

- Turn the right switch again in order to select the cooking temperature and to confirm press **OK**.

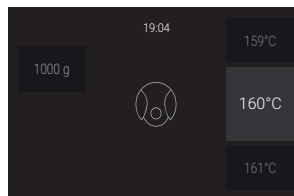

- Turn the right switch again in order to select the cooking setting and to confirm press **OK** to save the settings.

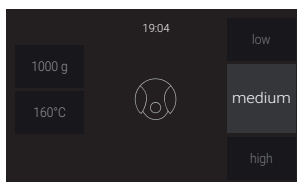

You will be returned to the settings view or you will return to the cooking process. Cooking times are automatically calculated. You can also set finish times and cooking time.

(See 11.6.1 and 11.6.3)

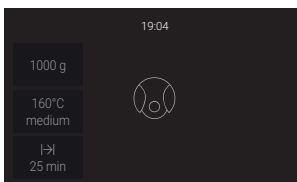

INFO



If a cooking process has already been started, it will only be possible to change the cooking settings within the first 10 minutes.

11.5.4 Changing the cooking temperature

A cooking temperature has been pre-set for all of the programmes.

The temperature can only be changed within a specified range in the case of the method of cooking programmes. For the functions, the temperature can be selected for a specific function within a range of 30°C (no temperature setting) and 300°C.

11.5.5 To change the cooking temperature:

- Touch the symbol .
- Then press the  symbol several times until you reach cooking temperature.
- Turn the right switch again in order to select the cooking temperature and to confirm press **OK**.

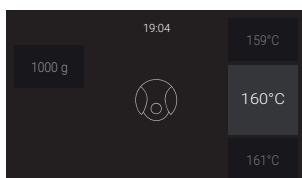

- Turn the right switch again in order to select the cooking setting and to confirm press **OK** to save the settings.

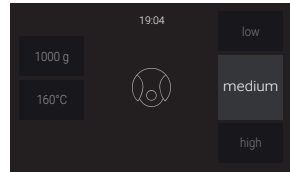

You will access the settings view. Cooking times are automatically calculated. You can also set finish times and cooking time. (See 11.6.1 and 11.6.3)

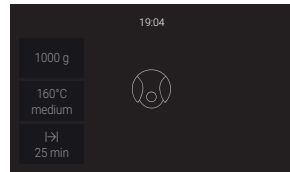

INFO

If a cooking process has already been started, it will only be possible to change the cooking settings within the first 10 minutes.

11.6. Time settings

11.6.1 Cooking time setting

In automatic programmes the cooking time is pre-set, but can be modified. There is no default time for the cooking functions. You can set the cooking time before or during a cooking process.

- Touch the symbol .

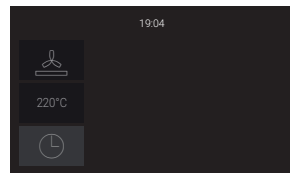

- Select the cooking time  function and press **OK** to confirm.

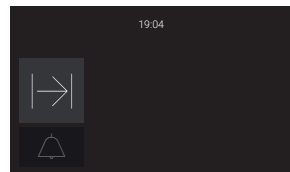

- Turn the right switch to set the cooking time. Then confirm by pressing **OK**.

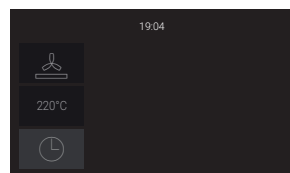

Operating the oven

Turn the right switch to set the end of cooking time (when the proposed end of cooking time is confirmed, the cooking process will start as soon as the setting view has been confirmed).
Confirm by pressing .

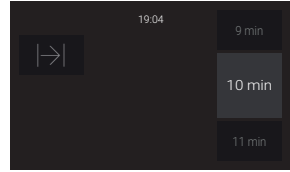

You will be returned to the settings view. The settings have now been saved.

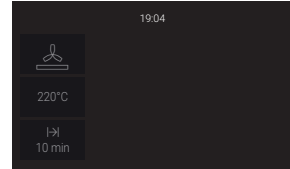

INFO

Once the programmed time has expired, the oven will switch off and an acoustic signal will sound. Press  to stop the acoustic signal. The oven will then show the current time of day. The oven is switched off.

11.6.2 Changing a cooking time

□ Touch the symbol .

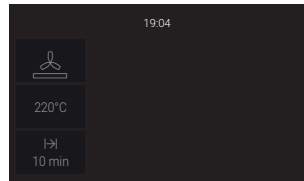

□ Select the cooking time  function and press  to confirm.

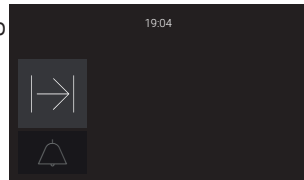

- Turn the right switch to change the cooking time.
- Turn the switch back to "0" to deactivate the cooking time.
- Then confirm by pressing .



In the next step you will need to set the end of cooking time. Confirm the proposed end of cooking time to start the process immediately. When you change the end of cooking time, you will also delay the start of the cooking procedure (See 11.6.3).

(this step will no longer need to be carried out when the cooking time is set during the cooking process).

- Confirm by pressing .

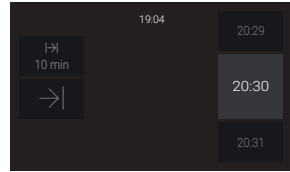

INFO

If you have deactivated the cooking time in a previous step, the cooking time will not need to be set.

You will be returned to the settings view.

- Confirm by pressing . The oven will commence the cooking process.

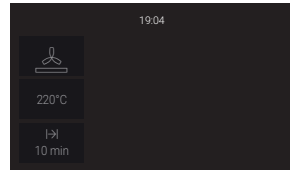

INFO!

Once the programmed time has expired, the oven will switch off and an acoustic signal will sound. Press  to stop the acoustic signal.

The oven will then show the current time of day. The oven is switched off.

You can change the pre-set cooking time or finish time by pressing the clock symbol  in standby mode. Change the cooking time and finish time with the steps described above.

11.6.3 Selecting a later end of cooking time

(only possible before starting the cooking process)

The end of cooking time is the time at which the oven switches off. You can use it to combine the cooking time and the end of cooking time.

Once you have set the cooking time and confirmed it with  (see 11.6.1), it will be possible for you to set the end of cooking time.

- Touch the symbol .

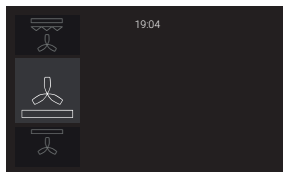

- Select the end of cooking time  function and press  to confirm.

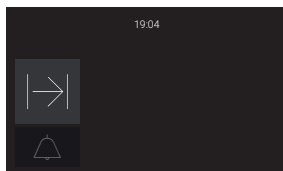

- Turn the right switch to set the cooking time. Then confirm by pressing .

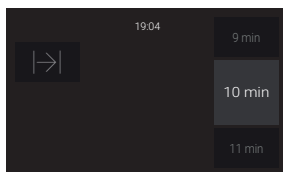

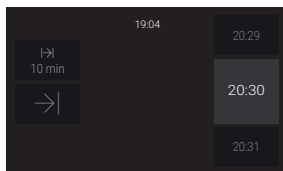

- Turn the right switch again to change the end of cooking time. Confirm by pressing .
(this step will no longer need to be carried out when the cooking time is set during the cooking process).

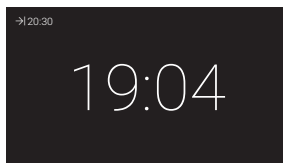

You will be returned to the settings view.

- To confirm a setting, press . The display will have changed to the standby mode by the time the cooking process starts.



Once the programmed time has expired, the oven will switch off and an acoustic signal will sound. Press  to stop the acoustic signal. The oven will then show the current time of day. The oven is switched off.



INFO!

You can delete a preprogrammed cooking process by pressing the  key. A signal will sound and the end of cooking time in the status display will go off.

11.6.4 Setting the timer to a minute minder

- Touch the  symbol in the standby mode.

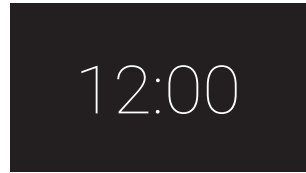

Turn the right switch to set the time. Then confirm by pressing



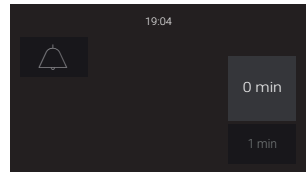

The oven will return to the standby mode.



After the expiry of the programmed set time, an acoustic signal will sound.

- Press the  key to stop the acoustic signal.

Changing the timer to a minute minder



- Touch the  symbol in the standby mode.
- Turn the right switch to set the time.
- Turn the right switch back to "0" to deactivate the timer.
- Then confirm by pressing . The oven will return to the standby mode.

11.6.5 Setting the timer in connection with a cooking process

Setting the timer function during cooking process will serve as an alarm, for example when you wish to turn your food at a specific point in time during the cooking process.

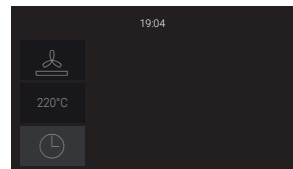
- Touch the  symbol in the settings view or during a cooking process.



- Turn the left switch and select the timer function .
To confirm, press  or turn the right switch.

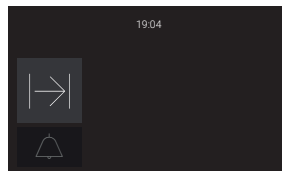

- Turn the right switch to set the time. Confirm by pressing .

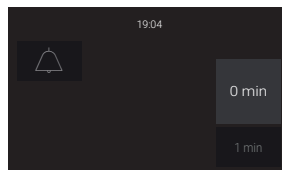

You will be returned to the first screen. In this case this is the settings view. The time set will from this point on be shown in the status display.

After the expiry of the set time, an acoustic signal will sound.

- Press the  key to stop the acoustic signal.

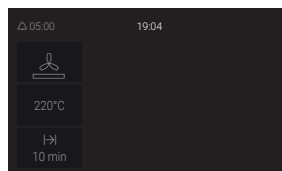

INFO!

The timer setting does not depend on the cooking time and it has no influence on the cooking process.

11.7. Memory function (depending on the model in question)





The oven is fitted with a storage function, which makes it possible to save a cooking process and an automatic programme.

11.7.1 Saving an additional programme

- Select a function or an automatic programme.
- Set all necessary settings.
- Now keep the  symbol pressed until the memory display appears.

The programme set can now be saved with  and can be used like any other baking, roasting or heating programme.

11.7.2 Opening an additional programme

- Press the  symbol on the initial screen to open the saved cooking process.
- Touch the symbol  and then immediately the symbol  to call up an automatic programme.
- To start the cooking process, press .





The programme called up will open. The values set can be changed without such changes being stored.



INFO

The settings in the memory function can still be changed with the steps described above. In order to overwrite the changed cooking settings, press the  symbol, until an acoustic signal sounds.

11.8. Rapid heating (has been activated as of the factory setting)

- Keep the  and  symbols pressed for 3 seconds until the following screen appears.
- Turn the right switch in order to switch the rapid heating function on and off in the banking functions  permitted by the oven .
- Confirm by pressing .

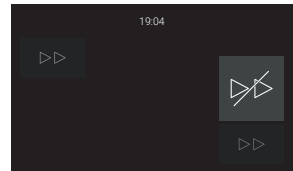



Your setting will remain until you make another change.



11.9. Childproof lock

The childproof lock protects the oven against unwanted changes to the settings and offers additional protection for children. The figures previously set may not be changed and the oven cannot be switched on.

11.9.1 Switching on the childproof lock

- The childproof lock can be activated when the oven is off or during a cooking process.
- Press the  and  symbols simultaneously for longer than 3 seconds until a long acoustic signal sounds and the symbol  appears. The keys and switches will now all be disabled.

11.9.2 Deactivating the childproof lock





- Then press the  and  symbols simultaneously for longer than 4 seconds to deactivate the childproof lock. A long acoustic signal will sound and the symbol  will no longer light up. The keys and switches will now all be released again.











INFO

Pyrolytic ovens have a double protection system: when the childproof lock is activated, the door will also not open.

11.10. Setting the demo mode



- Now press the  and the  symbols for 3 seconds until an acoustic signal sounds and the  symbol appears in the status display.
- Deactivate the demo mode by holding the same combination of keys for 4 seconds until an acoustic signal sounds and the  symbol in the status display goes off.

11.11. Factory settings

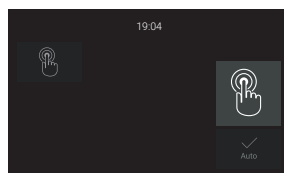
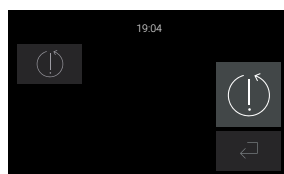
- Now keep the  and  symbols pressed for 3 seconds until the screen shown adjacent appears.
- Turn the right switch and select . Confirm by pressing . The oven goes on and all the settings will have been reset.
- Now keep the  and  symbols pressed for 3 seconds until the screen shown adjacent appears.
- Turn the right switch and select automatic confirmation  or manual confirmation .
- Confirm by pressing .



You will return to the standby display.

You will need to confirm each step actively for manual confirmation. The settings are automatically taken over after 8 seconds in the case of automatic confirmation. While the automatic confirmation is activated you can also actively confirm the settings with . (For safety reasons all the processes that serve to heat up the oven must be actively confirmed with .)



12. Special settings and additional settings and functions specific to models

12.1. Pyrolytic function





NOTICE

Please remove all foreign objects from the oven before you start the pyrolytic process.

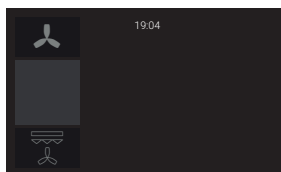
- Touch the symbol .
- Turn the right switch to select the pyrolytic function.
- Confirm by pressing . You will access the settings view.



- To confirm a setting, press .
- The oven will commence the cleaning process. The oven door will be automatically locked and will remain locked during the entire process for safety reasons. An acoustic signal is generated when the cleaning program has elapsed. Press  to stop the acoustic signal.
- You will return to the standby display. The symbol in the status bar will remain visible until you are able to open the oven door again.

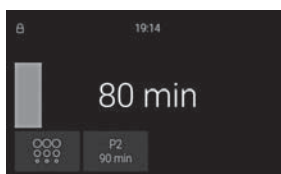
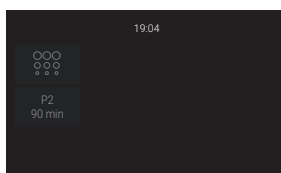
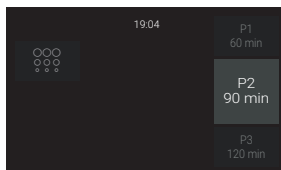

13. What to do if ...



Repairs may only be carried out by qualified staff members!

If your appliance is faulty, please check whether you can rectify the problem yourself by consulting these instructions for use. You may be able to rectify some problems yourself. They are described below.

If ...	What to do?
...the oven does not heat up	Turn the oven on.
	Set the required time.
	Make sure that the settings are correct.
	You will find more relevant information in the section on "automatic switch-off".
	See "Using the childproof lock"
	Close the door carefully. Make sure that the safety fuse is causing the problem. Contact an authorised skilled electrician if the fuse repeatedly triggers.
... the lighting does not work	Replace the lamp.
... neither sensors nor lighting function?	Check: Has the mains plug been connected? Is the fuse box in the building in an operational condition? Power failure? Childproof lock switched on?
... when one or several of the sensors do not respond to touch, but the lights can be switched on	Wait approx. 15 seconds or trigger the fuse and switch it on again. You may need to repeat this procedure! The keys then adjusted themselves, so they respond to touch again.
... one or more sensors do not even respond when the fuse is triggered and switched on again	Once the fuse has triggered twice and been switched on again, trigger it once more and inform Customer Service

If ...	What to do?
... the oven door glass cracked?	Switch off the oven and have Customer Service replace it
... the door sealing is damaged?	Replace the door sealing See «Replacing the door sealing».  Do not use the oven when the door sealing is damaged!
... the door sealing is damaged?	The oven can still be used. Replace the halogen lamp as quickly as possible when the oven is cold. See «Replacing the oven lamp».
...a powerful smell develops	Recycle the ökotherm® catalyst. See «Recycle the ökotherm® catalyst».
... the display will show F111 erscheint	Insert the plug of the KT sensor as far as possible into the socket
... an error code which is not on the chart appears in the display	Switch the oven off and then on again using the safety fuse in the home or the safety switch in the fuse box. Contact Customer Service if the error code appears in the display again.
... steam and condensation water are deposited on food and in the inside of the oven	Do not allow food to remain in the oven for more than 15 - 20 minutes after the cooking or baking process has ended.



ENERG
енергия · ενεργεια



Küppersbusch

B6350.0



70 L

0.81 kWh/cycle*

0.68 kWh/cycle*

* цикл · cyclus · portion · zyklus · πρόγραμμα · ciclo · tsúkkel · ohjelma · ciklus · ciklas · cikls · čiklu · cyclus · cykl · ciclu · program · cykel

65/2014

EEl _{cav} *	81
N° cav *	1
M	32 kg

* затв.отдел. · ovnrúm · θαλάμου · prostor za pečenje · kavità · ovenruimte · incintă · prostor za peko · kavitet



ENERG
енергия · ενέργεια



Küppersbusch **CB6350.0**



44 L



0.67 kWh/cycle*



0.59 kWh/cycle*

* цикъл · cyclus · portion · zyklus · πρόγραμμα · ciclo · tsükkel · ohjelma · ciklus · ciklas · cikls · ėiklu · cyclus · cykl · ciclu · program · cykel

65/2014

EEI _{cav} *	81
N° cav *	1
M	26 kg

* затв.отдел. · ovnrugm · θαλάμιου · prostor za pečenje · kavità · ovenruimte · incintă · prostor za peko · kavitet



ENERG
енергия · ενεργεια



Küppersbusch **BP6350.0**

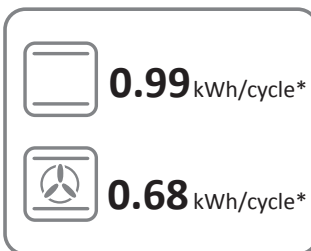

* цикъл · cyclus · portion · zyklus · πρόγραμμα · ciclo · tsúkkel · ohjelma · ciklus · ciklas · cikls · čiklu · cyclus · cykl · ciclu · program · cykel

65/2014

EEl _{cav} *	81
N° cav *	1
M	35 kg

* затв.отдел. · ovnrúm · θαλάμου · prostor za pečenje · kavità · ovenruimte · incintă · prostor za peko · kavitet



K01-180170/01

Cod.: 3370686-03

Küppersbusch

Küppersbusch Hausgeräte GmbH

Postfach 10 01 32, D-45801 Gelsenkirchen,
Küppersbuschstraße 16, D-45883 Gelsenkirchen
Telefon: (0209) 401-0, Telefax: (0209) 401-303
www.kueppersbusch.de

Teka Austria GmbH

Eitnergasse 13, A-1230 Wien
Telefon: (01) 86680-15, Telefax: (01) 86680-50
www.kueppersbusch.at

